

HSF

NOTES:

Rated Current: 5.0AMP.(20°C,1*2P-1*15P)

3.0AMP.(20°C,1*11P-1*40P) A4

Contact Resistance: 20mΩ Max.

Withstand Voltage: 1000V AC/DC

Insulation Resistance: 1000MΩ Min.

Operation Temperature: -40°C to +125°C(Gold Plating) A4

-40°C to +105°C(Tin Plating)

Contact Material: Copper Alloy

Contact Plating: Au or Sn Over 30u" Min Ni

Insulator Material: PA9T+G.F UL94V-0 BK A2

Recommended P.C.B Layout (Top Side)
(PCB BOARD TOLERANCE±0.05)
(PCB Thickness:T=1.60m)

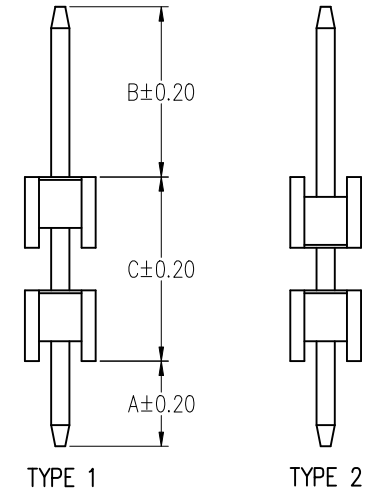
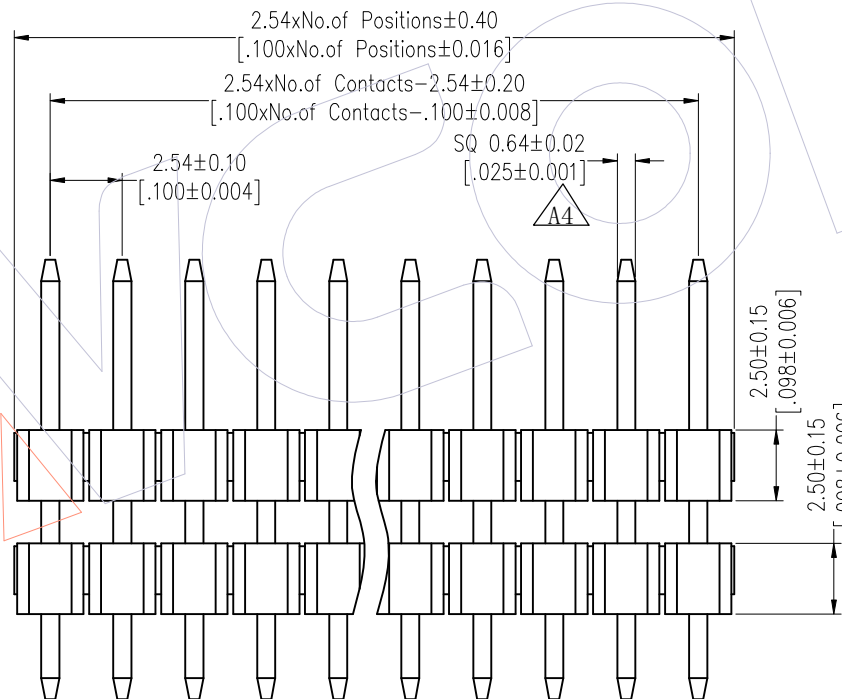
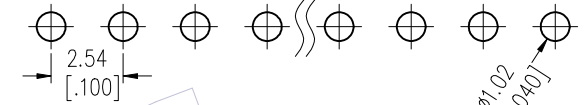

Ordering Information

1125- 2 1 XX XX S XXX C X XX A4

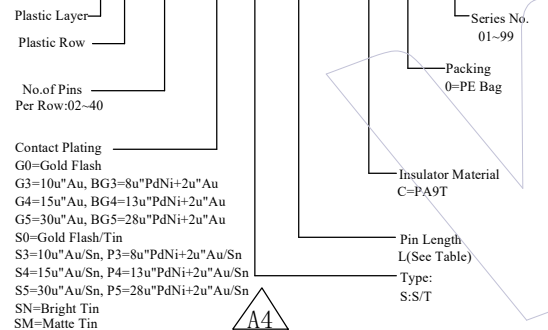

A4	2025/05/29	Standardization Drawing	CP	OPERATION	DRAW	DATE	SCALE	Fit	PART NO. 1125-21XXXXXXCXXX A3
A3	2021/01/26	Add CAP	DuYing	X.X ±0.40	CP	2025/05/29	UNIT	mm	
A2	2018/06/02	Cancel PBT & Modify P/N	XSR	X.XX ±0.25	CHECK	DATE	SIZE	A4	
A0	2012/05/17	NEW	William Chen	X.XXX ±0.15	TANG	2025/05/29	SHEET	1/3	
REV	DATE	MODIFICATION DESCRIPTION	CHANGE	Angle ± 3°	APPROVE	DATE	PROJ.	Customer NO.	
				DIM TOL	Steven Zhao	2025/05/29			



Http: www.wcon.com

WCON-Dongguan Tel: +86 769 85358920 Fax: +86 769 85358915 E-mail: sales@wcon.com	WCON-Kunshan Tel: +86 512 57468408 Fax: +86 512 57468468 E-mail: salesks@wcon.com
-------------------------------------------------------------------------------------------------------------------------------	----------------------------------------------------------------------------------------------------------------------------------

HSF

Packing:

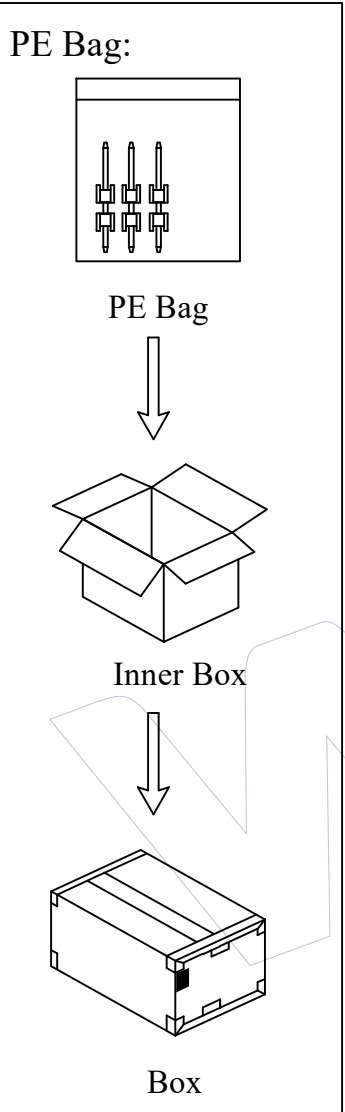

Table 1

Item	L	C	A	B	Mating
	13.0	6.5	3.0	3.5	2135/2150T/2157
	13.5			4.0	2145/2150
	14.5			5.0	2168T/2171T
	15.3	5.84		2171/2185X	
	13.5	7.0		3.5	2135/2150T/2157
	14.0			4.0	2145/2150
	15.0			5.0	2168T/2171T
	15.8			5.84	2171/2185X
	14.5	8.0		3.5	2135/2150T/2157
	15.0			4.0	2145/2150
	16.0			5.0	2168T/2171T
	16.8			5.84	2171/2185X
	15.5	9.0	3.5	2135/2150T/2157	
	16.0		4.0	2145/2150	
	17.0		5.0	2168T/2171T	
	17.8		5.84	2171/2185X	
	18.5	12.0	3.5	2135/2150T/2157	
	19.0		4.0	2145/2150	
	20.0		5.0	2168T/2171T	
	20.8		5.84	2171/2185X	
	20.5	14.0	3.5	2135/2150T/2157	
	21.0		4.0	2145/2150	
	22.0		5.0	2168T/2171T	
	22.8		5.84	2171/2185X	
Alternate					

Item	L	C	A	B	Mating
	12.0	6.5	2.0 (THR)	3.5	2135/2150T/2157
	12.5			4.0	2145/2150
	13.5			5.0	2168T/2171T
	14.3	5.84		2171/2185X	
	12.6	7.0		3.5	2135/2150T/2157
	13.0			4.0	2145/2150
	14.0			5.0	2168T/2171T
	14.8			5.84	2171/2185X
	13.5	8.0		3.5	2135/2150T/2157
	14.0			4.0	2145/2150
	15.0			5.0	2168T/2171T
	15.8			5.84	2171/2185X
	14.5	9.0	3.5	2135/2150T/2157	
	15.0		4.0	2145/2150	
	16.0		5.0	2168T/2171T	
	16.8		5.84	2171/2185X	
	17.5	12.0	3.5	2135/2150T/2157	
	18.0		4.0	2145/2150	
	19.0		5.0	2168T/2171T	
	19.8		5.84	2171/2185X	
	19.5	14.0	3.5	2135/2150T/2157	
	20.0		4.0	2145/2150	
	21.0		5.0	2168T/2171T	
	21.8		5.84	2171/2185X	
Alternate					

A4	2025/05/29	Standardization Drawing	CP	OPERATION		DRAW	DATE	SCALE	Fit	PART NO. 1125-21XXXXXXCXXX	
A3	2021/01/26	Add CAP	DuYing	X.X	±0.40	CP	2025/05/29	UNIT	mm		TITLE: PH2.54 SINGLE ROW DOUBLE PLASTIC 180° H=2.5
A2	2018/06/02	Cancel PBT & Modify P/N	XSR	X.XX	±0.25	CHECK	DATE	SIZE	A4		
A0	2012/05/17	NEW	William Chen	X.XXX	±0.15	TANG	2025/05/29	SHEET	2/3		
REV	DATE	MODIFICATION DESCRIPTION	CHANGE	Angle	± 3°	APPROVE	DATE	PROJ.		Customer NO.	
				DIM	TOL	Steven Zhao	2025/05/29				

Http: www.wcon.com



WCON-Dongguan
Tel: +86 769 85358920
Fax: +86 769 85358915
E-mail: sales@wcon.com

WCON-Kunshan
Tel: +86 512 57468408
Fax: +86 512 57468468
E-mail: salesks@wcon.com

HSF

Packaging Quantity Refers To The Following Table

PINS	Q'ty/Bag (10.0 < L ≤ 16.0)	PINS	Q'ty/Bag (10.0 < L ≤ 16.0)	PINS	Q'ty/Bag (16.0 < L ≤ 19.2)	PINS	Q'ty/Bag (16.0 < L ≤ 19.2)	PINS	Q'ty/Bag (19.2 < L ≤ 30.0)	PINS	Q'ty/Bag (19.2 < L ≤ 30.0)
1	1000	21	200	1	1000	21	200	1	1000	21	200
2	1000	22	200	2	1000	22	200	2	1000	22	200
3	1000	23	100	3	1000	23	200	3	1000	23	200
4	1000	24	200	4	1000	24	200	4	500	24	200
5	1000	25	200	5	400	25	200	5	500	25	200
6	1000	26	200	6	400	26	100	6	500	26	200
7	1000	27	200	7	400	27	200	7	500	27	200
8	500	28	200	8	400	28	200	8	500	28	200
9	500	29	200	9	400	29	200	9	300	29	200
10	300	30	200	10	300	30	100	10	300	30	100
11	500	31	200	11	300	31	100	11	300	31	100
12	500	32	200	12	300	32	100	12	200	32	100
13	500	33	200	13	300	33	100	13	200	33	100
14	200	34	200	14	300	34	100	14	200	34	100
15	500	35	200	15	300	35	100	15	200	35	100
16	400	36	200	16	200	36	100	16	200	36	100
17	400	37	200	17	200	37	100	17	150	37	100
18	300	38	200	18	200	38	100	18	200	38	100
19	300	39	200	19	200	39	100	19	200	39	100
20	200	40	100	20	200	40	100	20	150	40	100

A4	2025/05/29	Standardization Drawing	CP	OPERATION	DRAW	DATE	SCALE	Fit	PART NO. 1125-21XXXXXXCXXX 
A3	2021/01/26	Add CAP	DuYing	X.X ±0.40	CP	2025/05/29	UNIT	mm	
A2	2018/06/02	Cancel PBT & Modify P/N	XSR	X.XX ±0.25	CHECK	DATE	SIZE	A4	
A0	2012/05/17	NEW	William Chen	X.XXX ±0.15	TANG	2025/05/29	SHEET	3/3	
REV	DATE	MODIFICATION DESCRIPTION	CHANGE	Angle ± 3°	APPROVE	DATE	PROJ.		TITLE: PH2.54 SINGLE ROW DOUBLE PLASTIC 180° H=2.5 Customer NO.
				DIM TOL	Steven Zhao	2025/05/29			 Http: www.wcon.com WCON-Dongguan Tel: +86 769 85358920 Fax: +86 769 85358915 E-mail: sales@wcon.com WCON-Kunshan Tel: +86 512 57468408 Fax: +86 512 57468468 E-mail: salesks@wcon.com