

2.50mm pitch/wire-to-board/wire-to-wire Connector
2.50mm间距/线到板/线到线 连接器

Overview

The WD2500 series features a 2.5×3.3 mm pin pitch layout with individual pins capable of carrying up to 5A current. It supports aerial, panel, vertical, and horizontal mounting configurations to meet diverse application requirements.

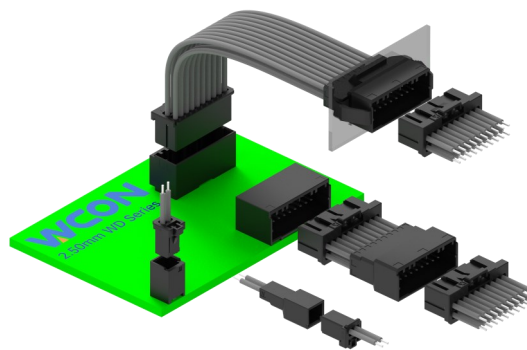

概述

WD2500系列采用2.5*3.3毫米间距针脚排布，单PIN电流可承载高达5A，空中对接、面板对接、垂直与水平对接满足各类使用要求。

Features and Benefits

- Suitable for high-temperature environments
- Wire-to-board, wire-to-wire connections
- Anti-misplug structure
- Latch design for enhanced connection reliability

产品特点

- 适用于高温环境
- 线到板，线到线连接
- 防呆设计防错插
- 锁扣设计，增强连接可靠性

Product Applications

- Industrial: Automated equipment, Servo motor, Robot

应用领域

- 工业：自动化设备、伺服电机、机器人

Standard 标准

- QCT 1067
- GB/T 5095

UL certification UL认证

- E248993

Material 材料

Part/零件	Material/材料	Finish/电镀	UL Flame retardant/阻燃等级
Male/公座	LCP	Black/黑色	UL94V-0
Housing/线端	PBT	Black/黑色	UL94V-0
Terminal/端子	phosphor bronze	Gold-plated/镀金 Tin-plated/镀锡	-

Production Specifications 产品规格

Current rating 额定电流	5A	Operating temperature Range:-40° C~+125° C (including temperature rise) Operating Humidity Range:20-80%	Storage temperature: Operating Humidity: 储存温度: 25±5° C 储存湿度: ≤60%
Voltage rating 额定电压	250V	工作温度范围: -40° C~+125° C(含温升) 工作湿度范围: 20-80%	
Item 项目	Condition 条件	Specification 规格	
Insulation Resistance 绝缘电阻	Measured at 500V DC for 1 minute 测试电压: 500V DC/1分钟	No less than 100MΩ 不少于100MΩ	
Withstanding voltage 耐电压	Test Voltage 1500V DC for 1 minute 测试电压: 1500V DC/1分钟	No breakdown, no discharge, leakage current <0.5mA 无击穿、无放电、漏电流<0.5mA	
Contact Resistance 接触电阻	Measured at 100mA and no higher than 20mV 用20 mV DC进行测量	Contact resistance: After environmental tests/ 20 mΩ max. 接触电阻: 测试后 20 mΩ 以下	
Vibration Resistance 抗振动	Frequency : 60-1200 Hz Accelerated Velocity : 12.1g Duration : 8 Hours/axis Vibration : X、Y、Z 频率: 60-1200 Hz 加速度: 12.1g 时长: 8小时/轴 振动方向: X、Y、Z	No electrical discontinuity of 1μs or greater 试验过程中未发生1 μs瞬断现象, 且外观无损伤, 电气性能正常	
Humidity (Steady state) 湿度	Temperature : -40° C~125° C Humidity: 90 ~95% (R.H) Duration : 240 hours 温度: -40° C~125° C 湿度: 90 ~95% (R.H) 时间: 240 小时	Contact resistance: After environmental tests/ 20 mΩ max. 接触电阻: 测试后 20 mΩ 以下	
Salt Spray 盐雾	Temperature:35± 2°C Solution concentration : 5%NaCl PHValue : 6.5 ~ 7.2 Duration : 48 hours (Gold) 12 hours (Tin) 温度: 35±2° C 溶液浓度: 5%NaCl PH值: 6.5~7.2 时间: 48 小时 (镀金) 12小时 (镀锡)	Contact resistance: After environmental tests/ 20 mΩ max. 接触电阻: 测试后 20 mΩ 以下	
Durability(Mating/un- mating) 插拔寿命	50 cycles (Gold) 循环50次 (镀金) 30 cycles (Tin) 循环30次 (镀锡)	Contact resistance: After environmental tests/ 20 mΩ max. 接触电阻: 测试后 20 mΩ 以下	

Dimensions 尺寸

PCB Layout 印刷电路板布局

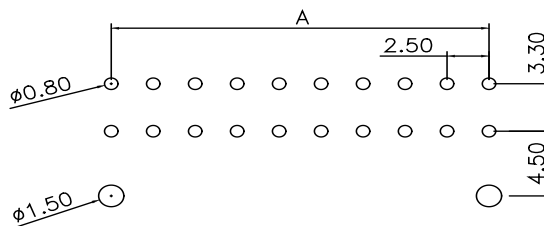
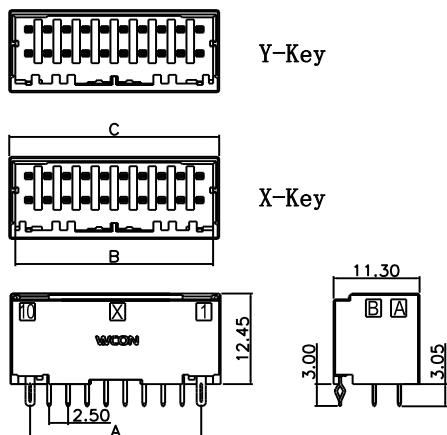

Ordering Information 订购信息

Circuit 芯数	Part number 型号		Plating电镀	Dimensions 尺寸 (mm)			Package 包 装Q'ty/Tube 只/管装	Remake 可量产状态	
	X-Key	Y-Key		A	B	C		X-Key	Y-Key
4	WD2500-2WS02XXBT01W	WD2500-2WS02XXBT02W	XX: W4=15u"Gold/ Matte Tin SN=Tin	2.50	6.00	7.60	76	*	*
6	WD2500-2WS03XXBT01W	WD2500-2WS03XXBT02W		5.00	8.50	10.10	68	*	*
8	WD2500-2WS04XXBT01W	WD2500-2WS04XXBT02W		7.50	11.00	12.60	52	*	*
10	WD2500-2WS05XXBT01W	WD2500-2WS05XXBT02W		10.00	13.50	15.10	42	*	*
12	WD2500-2WS06XXBT01W	WD2500-2WS06XXBT02W		12.50	16.00	17.60	36	*	*
16	WD2500-2WS08XXBT01W	WD2500-2WS08XXBT02W		17.50	21.00	22.60	27	*	
20	WD2500-2WS10XXBT01W	WD2500-2WS10XXBT02W		22.50	26.00	27.60	22	*	*

Note: * stands for mass production . 注: *代表可量产

Dimensions 尺寸

PCB Layout 印刷电路板布局

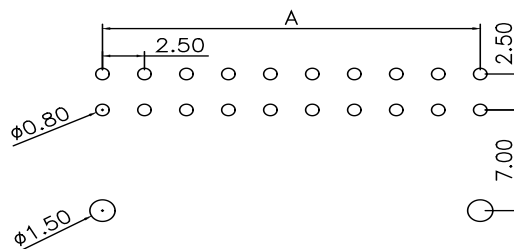
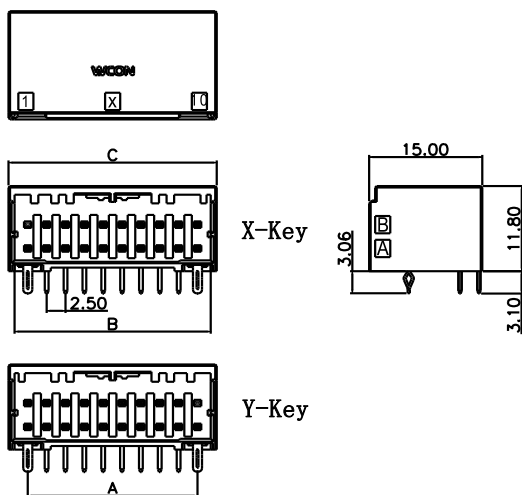

Ordering Information 订购信息

Circuit 芯数	Part number 型号		Plating 电镀	Dimensions 尺寸 (mm)			Package 包 装Q'ty/Tube 只/管装	Remake 可量产状态	
	X-Key	Y-Key		A	B	C		X-Key	Y-Key
4	WD2500-2WR02XXBT01W	WD2500-2WR02XXBT02W	XX: W4=15u"Gold/ Matte Tin SN=Tin	2.50	6.00	7.60	76	*	
6	WD2500-2WR03XXBT01W	WD2500-2WR03XXBT02W		5.00	8.50	10.10	68	*	
8	WD2500-2WR04XXBT01W	WD2500-2WR04XXBT02W		7.50	11.00	12.60	52	*	
12	WD2500-2WR06XXBT01W	WD2500-2WR06XXBT02W		12.50	16.00	17.60	36	*	
16	WD2500-2WR08XXBT01W	WD2500-2WR08XXBT02W		17.50	21.00	22.60	27	*	
20	WD2500-2WR10XXBT01W	WD2500-2WR10XXBT02W		22.50	26.00	27.60	22	*	

Note: * stands for mass production . 注: *代表可量产

Dimensions 尺寸

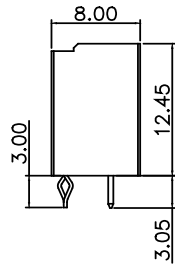
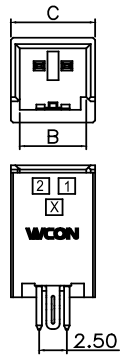

PCB Layout 印刷电路板布局

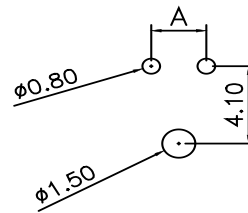

Ordering Information 订购信息

Circuit 芯数	Part number 型号	Plating 电镀	Dimensions 尺寸 (mm)			Package 包 装Q'ty/Tray 只/盒装	Remake 可量产状态
	X-Key		A	B	C		X-Key
2	WD2500-1WS02XXBT01W	XX: W4=15u"Gold/Matte Tin SN=Tin	2.50	6.00	7.60	117	*

Note: * stands for mass production . 注: *代表可量产

Dimensions 尺寸

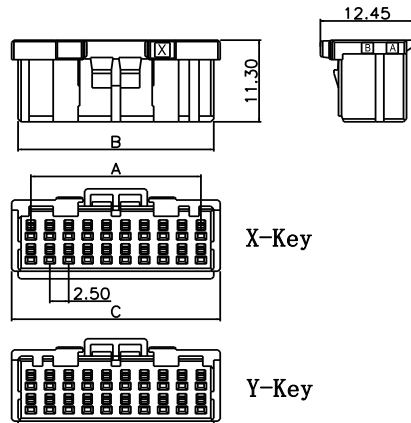

WD2500 Series

Ordering Information 订购信息

Circuit 芯数	Part number 型号		Dimensions 尺寸 (mm)			Parkage 包 装Q'ty/Bag 只/袋装	Remake 可量产状态	
	X-Key	Y-Key	A	B	C		X-Key	Y-Key
4	WD2500-2H02B001W	WD2500-2H02B002W	2.50	5.90	7.60	500	*	*
6	WD2500-2H03B001W	WD2500-2H03B002W	5.00	8.40	10.10	500	*	*
8	WD2500-2H04B001W	WD2500-2H04B002W	7.50	10.90	12.60	500	*	*
10	WD2500-2H05B001W	WD2500-2H05B002W	10.00	13.40	15.10	500	*	*
12	WD2500-2H06B001W	WD2500-2H06B002W	12.50	15.90	17.60	500	*	*
16	WD2500-2H08B001W	WD2500-2H08B002W	17.50	20.90	22.60	300	*	
20	WD2500-2H10B001W	WD2500-2H10B002W	22.50	25.90	27.60	200	*	*

Note: * stands for mass production . 注: *代表可量产

Dimensions 尺寸

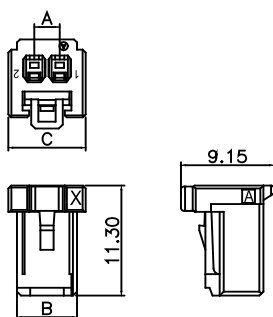

Ordering Information 订购信息

Circuit 芯数	Part number 型号	Dimensions 尺寸 (mm)			Parkage 包 装Q'ty/Bag 只/袋装	Remake 可量产状态
	X-Key	A	B	C		X-Key
2	WD2500-1H02B001W	2.50	5.90	7.60	500	*

Note: * stands for mass production . 注: *代表可量产

Dimensions 尺寸

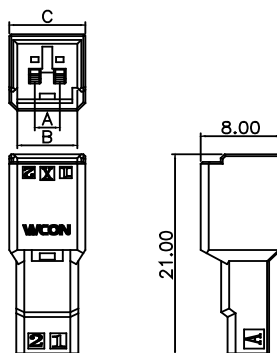

Ordering Information 订购信息

Circuit 芯数	Part number 型号	Dimensions 尺寸 (mm)			Parkage 包 装Q'ty/Bag 只/袋装	Remake 可量产状态
	X-Key	A	B	C		X-Key
2	WD2500-1HK02B001W	2.50	6.00	7.60	500	*

Note: * stands for mass production . 注: *代表可量产

Dimensions 尺寸

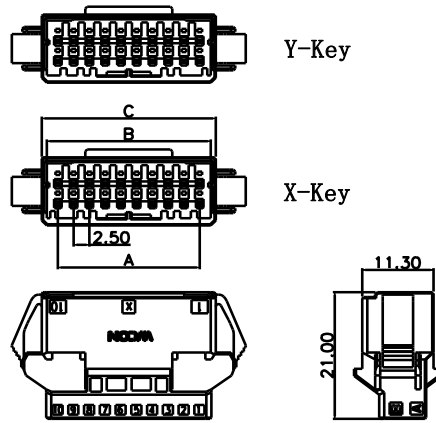

Ordering Information 订购信息

Circuit 芯数	Part number 型号		Dimensions 尺寸 (mm)			Package 包 装Q'ty/Bag 只/袋装	Remake 可量产状态	
	X-Key	Y-Key	A	B	C		X-Key	Y-Key
4	WD2500-2HG02B001W	WD2500-2HG02B002W	2.50	6.00	7.60	500	*	*
6	WD2500-2HG03B001W	WD2500-2HG03B002W	5.00	8.50	10.10	500	*	*
8	WD2500-2HG04B001W	WD2500-2HG04B002W	7.50	11.00	12.60	500	*	*
12	WD2500-2HG06B001W	WD2500-2HG06B002W	12.50	16.00	17.60	500	*	*
20	WD2500-2HG10B001W	WD2500-2HG10B002W	22.50	26.00	27.60	200	*	*

Note: * stands for mass production . 注: *代表可量产

Dimensions 尺寸

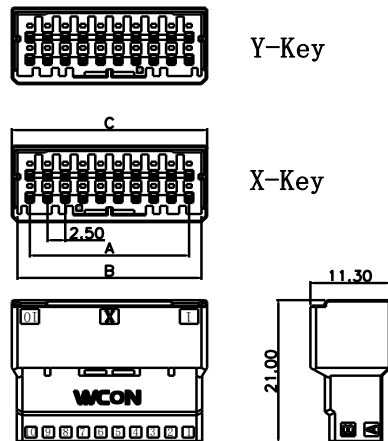

Ordering Information 订购信息

Circuit 芯数	Part number 型号		Dimensions 尺寸 (mm)			Package 包 装Q'ty/Bag 只/袋装	Remake 可量产状态	
	X-Key	Y-Key	A	B	C		X-Key	Y-Key
4	WD2500-2HK02B001W	WD2500-2HK02B002W	2.50	6.00	7.60	500	*	
6	WD2500-2HK03B001W	WD2500-2HK03B002W	5.00	8.50	10.10	500	*	
8	WD2500-2HK04B001W	WD2500-2HK04B002W	7.50	11.00	12.60	500		
12	WD2500-2HK06B001W	WD2500-2HK06B002W	12.50	16.00	17.60	500	*	
20	WD2500-2HK10B001W	WD2500-2HK10B002W	22.50	26.00	27.60	200	*	*

Note: * stands for mass production . 注: *代表可量产

WD2500 Series

Adaptor Terminal 适配端子 (Female)

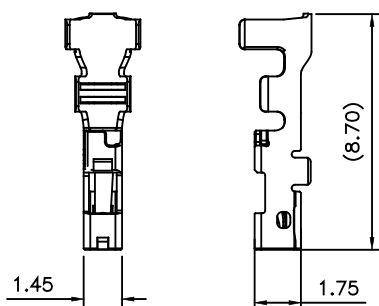

型号 Model number	线径 Wire Diameter	电镀 Plating
WD3500-3TP18S401	18~22 AWG	Gold
WD3500-TP18SN01	18~22 AWG	Tin
WD3500-3TP22S401	22~28 AWG	Gold
WD3500-TP22SN01	22~28 AWG	Tin
WD3500-3TP28S401	22~28 AWG	Gold
WD3500-TP28SN01	22~28 AWG	Tin
WD3500-3TP30S401	28~30AWG	Gold
WD3500-TP30SN01	28~30AWG	Tin

Terminal Crimp specification 端子压接规范

型号 Model number	电线规格 Wire size	线缆 OD (mm) Cable OD (mm)	导体铆压 (A-A) Conductor crimp			绝缘体铆压 (B-B) Insulation crimp	
			压接宽度CB1 Crimping width CB1±0.03mm	压接宽度CBm1 Crimping height CBm1+0.05mm	压接高度 Crimping height CH1±0.03mm	压接宽度CBm2 Crimping width CBm2±0.05mm	压接高度CH2 Crimping width CH2±0.08mm
WD3500-XTP18XX01 (2L)	18AWG	φ1.4~φ2.2	1.50+/-0.05	1.50+/-0.05	0.95+/-0.05	2.1Max	2.2Max
	20AWG		1.45+/-0.05	1.45+/-0.05	0.85+/-0.05		
	22AWG		1.35+/-0.05	1.35+/-0.05	0.78+/-0.05		
WD3500-XTP22XX01 (L)	22AWG	φ1.08~φ1.9	1.35+/-0.05	1.35+/-0.05	0.78+/-0.05	1.35~1.55	1.8Max
	24AWG		1.30+/-0.05	1.30+/-0.05	0.70+/-0.05		
	26AWG		1.25+/-0.05	1.25+/-0.05	0.60+/-0.05		
	28AWG		1.25+/-0.05	1.25+/-0.05	0.55+/-0.05		
WD3500-XTP28XX01 (M)	22AWG	φ1.08~φ1.6	1.35+/-0.05	1.35+/-0.05	0.78+/-0.05	1.35~1.55	1.8Max
	24AWG		1.30+/-0.05	1.30+/-0.05	0.70+/-0.05		
	26AWG		1.25+/-0.05	1.25+/-0.05	0.60+/-0.05		
	28AWG		1.25+/-0.05	1.25+/-0.05	0.55+/-0.05		
WD3500-XTP30XX01 (S)	28AWG	φ0.6~φ1.2	1.25+/-0.05	1.25+/-0.05	0.55+/-0.05	1.35 Max	1.7Max
	30AWG		1.25+/-0.05	1.25+/-0.05	0.50+/-0.05		

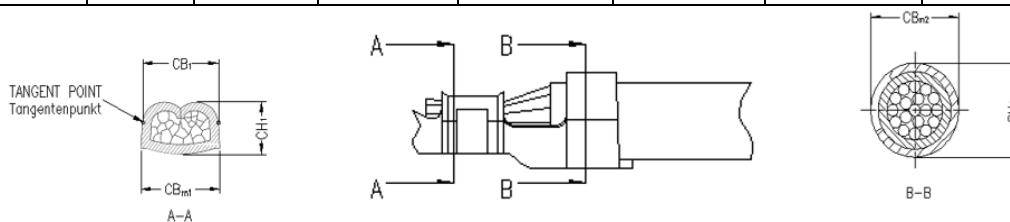

Adaptor Terminal 适配端子 (Male)

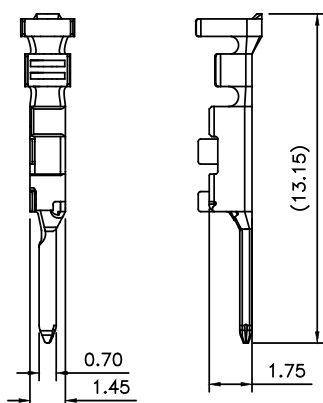

型号 Model number	线径 Wire Diameter	电镀 Plating
WD3500-MTP18S401	18~22 AWG	Gold
WD3500-MP18SN01	18~22 AWG	Tin
WD3500-MTP22S401	22~28 AWG	Gold
WD3500-MTP22SN01	22~28 AWG	Tin
WD3500-MTP28S401	22~28 AWG	Gold
WD3500-MTP28SN01	22~28 AWG	Tin
WD3500-MTP30S401	28~30AWG	Gold
WD3500-MTP30SN01	28~30AWG	Tin

Terminal Crimp specification 端子压接规范

型号 Model number	电线规格 Wire size	线缆 OD (mm) Cable OD (mm)	导体铆压 (A-A) Conductor crimp			绝缘体铆压 (B-B) Insulation crimp	
			压接宽度CB1 Crimping width CB1±0.03mm	压接宽度CBm1 Crimping height CBm1+0.05mm	压接高度 Crimping height CH1±0.03mm	压接宽度CBm2 Crimping width CBm2±0.05mm	压接高度CH2 Crimping width CH2±0.08mm
WD3500-XTP18XX01 (2L)	18AWG	φ1.4~φ2.2	1.50+/-0.05	1.50+/-0.05	0.95+/-0.05	2.1Max	2.2Max
	20AWG		1.45+/-0.05	1.45+/-0.05	0.85+/-0.05		
	22AWG		1.35+/-0.05	1.35+/-0.05	0.78+/-0.05		
WD3500-XTP22XX01 (L)	22AWG	φ1.08~φ1.9	1.35+/-0.05	1.35+/-0.05	0.78+/-0.05	1.35~1.55	1.8Max
	24AWG		1.30+/-0.05	1.30+/-0.05	0.70+/-0.05		
	26AWG		1.25+/-0.05	1.25+/-0.05	0.60+/-0.05		
	28AWG		1.25+/-0.05	1.25+/-0.05	0.55+/-0.05		
WD3500-XTP28XX01 (M)	22AWG	φ1.08~φ1.6	1.35+/-0.05	1.35+/-0.05	0.78+/-0.05	1.35~1.55	1.8Max
	24AWG		1.30+/-0.05	1.30+/-0.05	0.70+/-0.05		
	26AWG		1.25+/-0.05	1.25+/-0.05	0.60+/-0.05		
	28AWG		1.25+/-0.05	1.25+/-0.05	0.55+/-0.05		
WD3500-XTP30XX01 (S)	28AWG	φ0.6~φ1.2	1.25+/-0.05	1.25+/-0.05	0.55+/-0.05	1.35 Max	1.7Max
	30AWG		1.25+/-0.05	1.25+/-0.05	0.50+/-0.05		

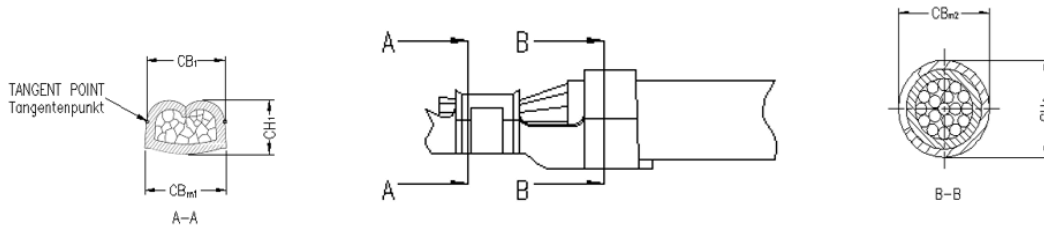

Model number allocation 型号命名

WD2500	-	X	XX	XX	XX	X	T	XX	X
(1)		(2)	(3)	(4)	(5)	(6)	(7)	(8)	(9)
(1) Series (系列): WD2500 Series					(6) Color (颜色): B=Black				
(2) Number of rows (排数): 1=Single Row、2=Double Row					(7) Packing (包装): T=Tube				
(3) Product Type (产品类型): WS=180° DIP、WR=90° DIP					(8) Fool Proofing (防呆): 01=X-Key、02=Y-Key				
(4) Single Row No (单排针数): 02=2P.....10=10P					(9) LOGO: W=With LOGO、Blank=Without LOGO				
(5) Plating (电镀): W4=15u"Gold/Matte Tin、SN=Tin									

WD2500 Series

WD2500	-	2	H	XX	X	0	XX	X
(1)		(2)	(3)	(4)	(5)	(6)	(7)	(8)
(1) Series (系列): WD2500 Series				(5) Color (颜色): B=Black				
(2) Number of rows (排数): 1=Single Row、2=Double Row				(6) Packing (包装): 0=PE Bag				
(3) Product Type (产品类型): H=Housing				(7) Fool Proofing (防呆): 01=X-Key、02=Y-Key				
(4) Single Row No (单排针数): 02=2P.....10=10P				(8) LOGO: W=With LOGO、Blank=Without LOGO				

WD2500	-	2	XX	XX	X	0	XX	X
(1)		(2)	(3)	(4)	(5)	(6)	(7)	(8)
(1) Series (系列): WD2500 Series				(5) Color (颜色): B=Black				
(2) Number of rows (排数): 1=Single Row、2=Double Row				(6) Packing (包装): 0=PE Bag				
(3) Product Type (产品类型): HG=Panel-mounted housing、HK=Airborne docking-type housing				(7) Fool Proofing (防呆): 01=X-Key、02=Y-Key				
(4) Single Row No (单排针数): 02=2P.....10=10P				(8) LOGO: W=With LOGO、Blank=Without LOGO				

Contact Us 联系我们

维峰电子股份有限公司 (总部)
WCON ELECTRONICS CO.,LTD(HQ)
地址:广东省东莞市虎门镇大宁文明路15号
Add :No.15,Wenming Road,Danling Community, Humen Town,
Dongguan, Guangdong.523930, China

昆山维康电子有限公司
KUNSHAN WCON ELECTRONICS CO.,LTD(East of China)
地址:昆山市千灯镇汶浦中路169号
Add : No.169, WenPu Middle Road, QianDeng Town, Kunshan
City, Jiangsu Province, China

合肥维峰电子有限公司
HEFEI WCON ELECTRONICS CO.,LTD
地址:安徽省合肥市高新技术开发区绿城科技园E栋2楼
Add : 2F, Building E, Greentown Science Park,High-tech Development Zone, Hefei, Anhui,China

维康电子(泰国)有限公司
WCON ELECTRONICS (Thailand) CO.,LTD
地址:泰国巴真武里府西玛铺县华瓦区洛加纳工业园
Add: VG3C+H57, Hua Wa, Si Maha Phot District, Prachin Buri
25140, Thailand

销售联系方式 Sales Contacts

国际客户部 International Sales Department
salesdg01@wcon.com
salesdg05@wcon.com

大客户专线 Key Account Line

华南: salesdg28@wcon.com
华东: salesks@wcon.com

中小客户专线 Small and Medium-sized Account Line

华南: salesdg10@wcon.com
华东: salesks01@wcon.com

网络销售 Online sales

salesdg26@wcon.com



Official Website



Product e-catalog



WeChat Public#



TikTok Public#