

HSF

NOTES:

Rated Current: 5.0AMP.(20°C, 1*2P-1*15P)
 3.0AMP.(20°C, 1*16P-1*40P)
 Contact Resistance: 20mΩ Max.
 Withstand Voltage: 1000V AC/DC
 Insulation Resistance: 1000MΩ Min.
 Operation Temperature: -40°C to +125°C (Gold Plating)
 -40°C to +105°C (Tin Plating)

Contact Material: Copper Alloy $\triangle A2$
 Contact Plating: Au or Sn Over 30u" Min Ni $\triangle A2$
 Insulator Material: PA9T+G.F UL94V-0 BK $\triangle A2$

Ordering Information $\triangle A1$ $\triangle A2$

1125-1 1 XX XX Z XXX C X XX

Plastic Layer
 Plastic Row
 No. of Pins Per Row: 02-40
 Contact Plating
 G0=Gold Flash
 G3=10u"Au, BG3=8u"PdNi+2u"Au
 G4=15u"Au, BG4=13u"PdNi+2u"Au
 G5=30u"Au, BG5=28u"PdNi+2u"Au
 S0=Gold Flash/Tin
 S3=10u"Au/Sn, P3=8u"PdNi+2u"Au/Sn
 S4=15u"Au/Sn, P4=13u"PdNi+2u"Au/Sn
 S5=30u"Au/Sn, P5=28u"PdNi+2u"Au/Sn
 SN=Bright Tin
 SM=Matte Tin

Series No. 01-99
 Packing
 T=Tube
 P=Tube+CAP
 R=Tape & Reel+CAP
 Insulator Material
 C=PA9T
 Pin Length
 L(See Table)
 Type:
 Z:R/A SMT

Item	Pin Length	A	B	Mating
Standard	9.0	3.0	3.5	2135/2150T/2157
	9.5		4.0	2145/2150
	10.5		5.0	2168T/2171T
	11.5		5.84	2171/2185X
Alternate				

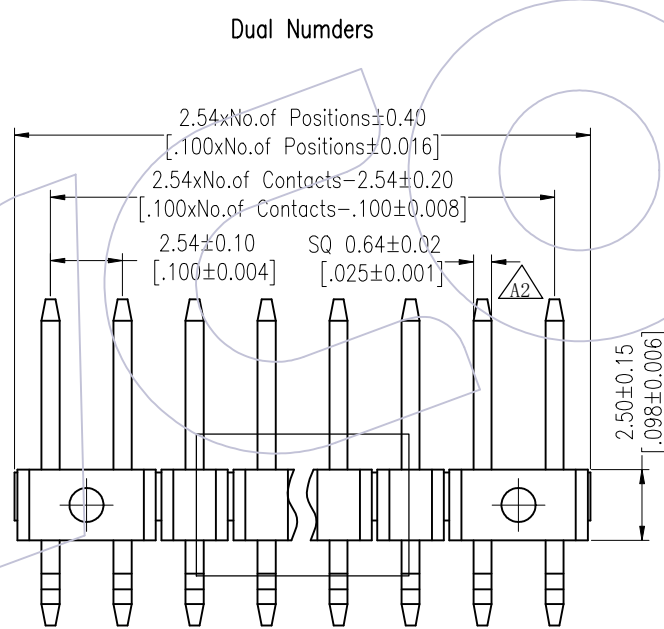
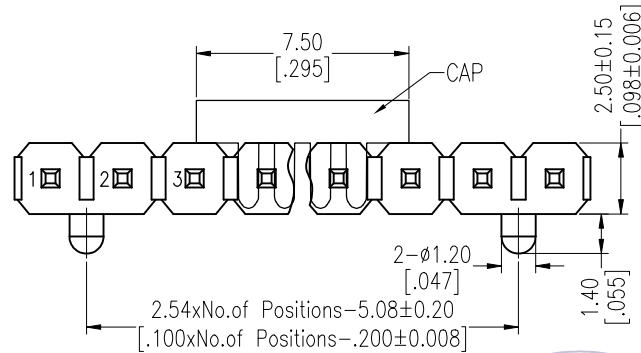

Recommended P.C.B Layout (Top Side)
 (PCB BOARD TOLERANCE ±0.05)
 (PCB Thickness: T=1.60m)

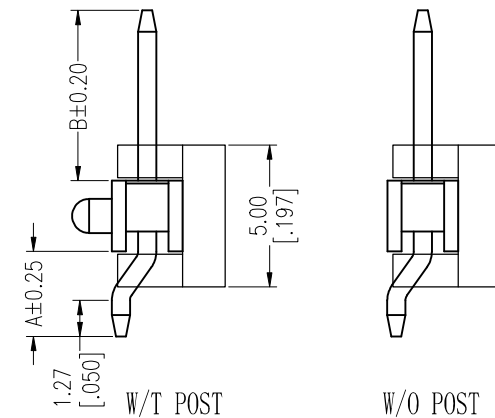
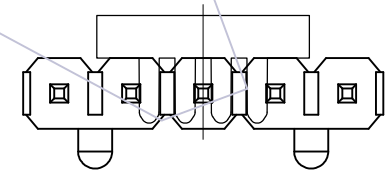
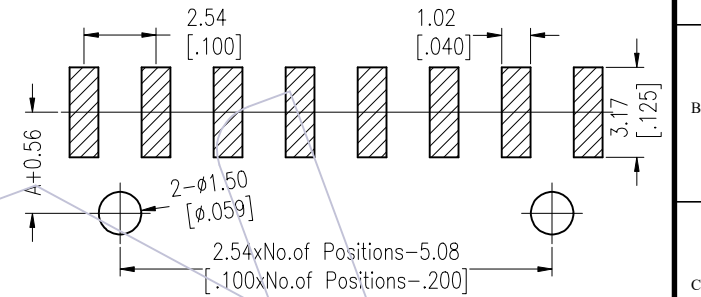

REV	DATE	MODIFICATION DESCRIPTION	CHANGE	OPERATION	DRAW	DATE	SCALE	Fit	PART NO.
A2	2025/03/06	Standardization Drawing	CP	x.X ±0.40	CP	2025/03/06	UNIT	mm	1125-11XXXXXXXCXXX
A1	2018/01/22	Modify P/N	Ruipeng	x.XX ±0.25	CHECK	2025/03/06	SIZE	A4	TITLE: PH2.54 SINGLE ROW 90° SMT H=2.5 WITH POST
AO	2012/05/17	NEW	William Chen	x.XXX ±0.15	TANG	2025/03/06	SHEET	1/3	Customer NO.
				Angle ± 3'	APPROVE	2025/03/06	PROJ.		
				DIM TOL	Steven Zhao				

WCON
 Http: www.wcon.com

WCON-Dongguan
 Tel: +86 769 85358920
 Fax: +86 769 85358915
 E-mail: sales@wcon.com

WCON-Kunshan
 Tel: +86 512 57468408
 Fax: +86 512 57468468
 E-mail: sales@wcon.com

HSF

Packing:

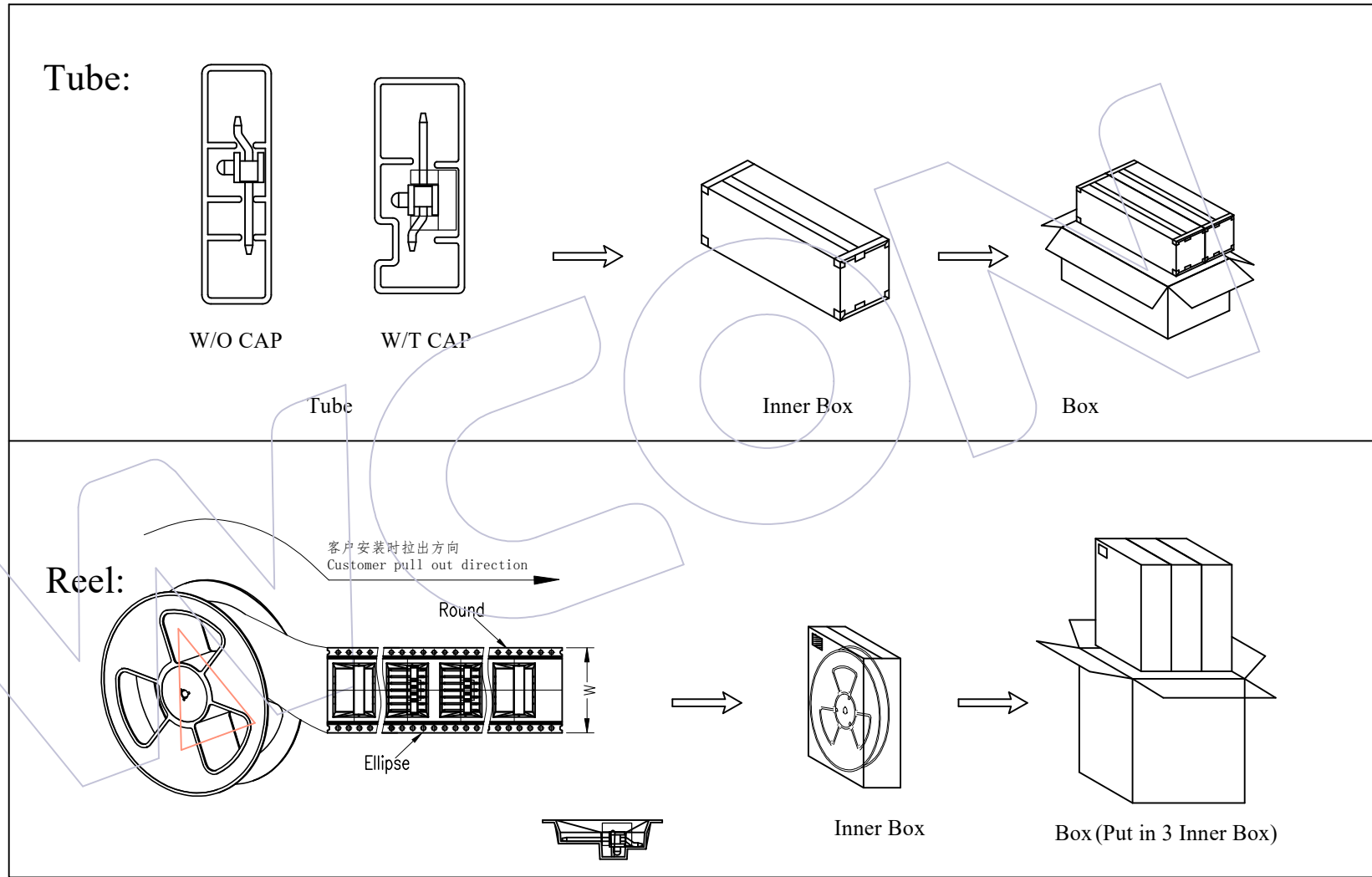

				OPERATION	DRAW	DATE	SCALE	Fit	PART NO.
A2	2025/03/06	Standardization Drawing	CP	x.X ±0.40	CP	2025/03/06	UNIT	mm	1125-11XXXXXXXCXX
A1	2018/01/22	Modify P/N	Ruipeng	x.XX ±0.25	CHECK	DATE	SIZE	A4	TITLE:
A0	2012/05/17	NEW	William Chen	x.XXX ±0.15	TANG	2025/03/06	SHEET	2/3	PH2.54 SINGLE ROW 90° SMT H=2.5 WITH POST
REV	DATE	MODIFICATION DESCRIPTION	CHANGE	Angle ± 3'	APPROVE	DATE	PROJ.		Customer NO.
				DIM TOL	Steven Zhao	2025/03/06			

WCON

Http: www.wcon.com

WCON-Dongguan WCON-Kunshan

Tel: +86 769 85358920 Tel: +86 512 57468408

Fax: +86 769 85358915 Fax: +86 512 57468468

E-mail: sales@wcon.com E-mail: salesks@wcon.com

HSF

Packaging Quantity Refers To The Following Table

B=3.5/4.0/5.0

B=5.84

PINS	Q' ty/Tube	Q' ty/Inner Box	Q' ty/Box
4	57	6,480	12,960
5	45	5,400	10,800
6	38	4,560	9,120
7	32	3,840	7,680
8	28	3,360	6,720
9	25	3,000	6,000
10	22	2,640	5,280
11	20	2,400	4,800
12	18	2,160	4,320
13	17	2,040	4,080
14	16	1,920	3,840
15	15	1,800	3,600
16	14	1,680	3,360
17	13	1,560	3,120
18	12	1,440	2,880
19	11	1,320	2,640
20	11	1,320	2,640
21	10	1,200	2,400
22	10	1,200	2,400

PINS	Q' ty/Tube	Q' ty/Inner Box	Q' ty/Box
23	9	1,080	2,160
24	9	1,080	2,160
25	9	1,080	2,160
26	8	960	1,920
27	8	960	1,920
28	8	960	1,920
29	7	840	1,680
30	7	840	1,680
31	7	840	1,680
32	7	840	1,680
33	6	720	1,440
34	6	720	1,440
35	6	720	1,440
36	6	720	1,440
37	6	720	1,440
38	5	600	1,200
39	5	600	1,200
40	5	600	1,200

PINS	W	Q' ty/Reel	Q' ty/Inner Box	Q' ty/Box
2	16	700	2,800	8,400
3	24	700	2,100	6,300
4	24	700	2,100	6,300
5	24	700	2,100	6,300
6	32	700	1,400	4,200
7	32	700	1,400	4,200
8	44	700	1,400	4,200
9	44	700	1,400	4,200
10	44	700	1,400	4,200
11	44	700	1,400	4,200
12	44	700	1,400	4,200
13	56	700	700	2,100
14	56	700	700	2,100
15	56	700	700	2,100
16	56	700	700	2,100
17	56	700	700	2,100
18	72	700	700	2,100
19	72	700	700	2,100
20	72	700	700	2,100
21	72	700	700	2,100
22	72	700	700	2,100
23	72	700	700	2,100
24	88	700	700	2,100
25	88	700	700	2,100
26	88	700	700	2,100
27	88	700	700	2,100

PINS	W	Q' ty/Reel	Q' ty/Inner Box	Q' ty/Box
2	16	500	2,000	6,000
3	24	500	1,500	4,500
4	24	500	1,500	4,500
5	24	500	1,500	4,500
6	32	500	1,000	3,000
7	32	500	1,000	3,000
8	44	500	1,000	3,000
9	44	500	1,000	3,000
10	44	500	1,000	3,000
11	44	500	1,000	3,000
12	44	500	1,000	3,000
13	56	500	500	1,500
14	56	500	500	1,500
15	56	500	500	1,500
16	56	500	500	1,500
17	56	500	500	1,500
18	72	500	500	1,500
19	72	500	500	1,500
20	72	500	500	1,500
21	72	500	500	1,500
22	72	500	500	1,500
23	72	500	500	1,500
24	88	500	500	1,500
25	88	500	500	1,500
26	88	500	500	1,500
27	88	500	500	1,500

				OPERATION	DRAW	DATE	SCALE	Fit	PART NO.	 <p>Http: www.wcon.com</p> <p>WCON-Dongguan Tel: +86 769 85358920 Fax: +86 769 85358915 E-mail: sales@wcon.com</p> <p>WCON-Kunshan Tel: +86 512 57468408 Fax: +86 512 57468468 E-mail: sales@wcon.com</p>
A2	2025/03/06	Standardization Drawing	CP	x.X ±0.40	CP	2025/03/06	UNIT	mm	1125-11XXXXXXXCXX	
A1	2018/01/22	Modify P/N	Ruipeng	x.xx ±0.25	CHECK	DATE	SIZE	A4	TITLE:	
A0	2012/05/17	NEW	William Chen	x.xxx ±0.15	TANG	2025/03/06	SHEET	3/3	PH2.54 SINGLE ROW 90° SMT H=2.5 WITH POST	
REV	DATE	MODIFICATION DESCRIPTION	CHANGE	Angle ± 3'	APPROVE	DATE	PROJ.	Customer NO.		
				DIM TOL	Steven Zhao	2025/03/06				