

# HSF

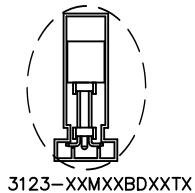

3123-XXMXXBDXXTX

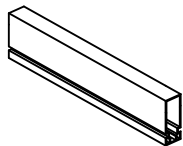

No: 1

产品装入真空管内  
SG-B18 (600mm方型真空管)

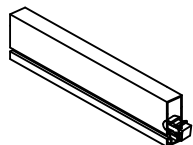

No: 2

塞塑胶塞



No: 3

20管为一扎套PE-31袋中, 内附1包干燥剂  
封口机封口, 封箱胶缠绕PE袋两端  
再贴标签

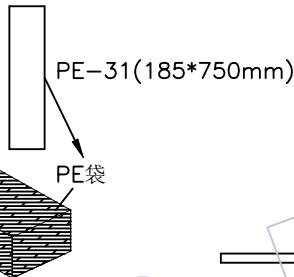

No: 4

真空管装入内箱(3扎/内箱)  
内箱规格: CTN-10A(双坑A=B 63\*15\*15CM)

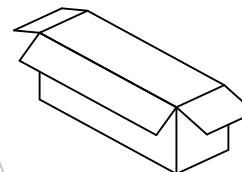

No: 5

封箱及贴标签于内箱侧面的左上角  
(60管/内箱)

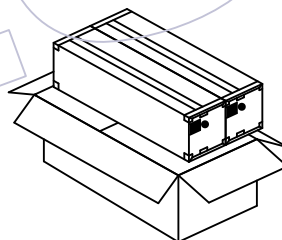

No: 6

内箱放入外箱(2内箱/外箱)  
外箱规格: CTN-10C(双坑A=A 65\*33\*17CM)

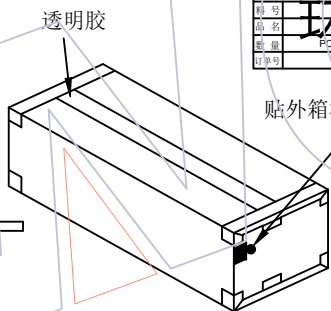

No: 7

封箱及贴标签于外箱侧面的左上角

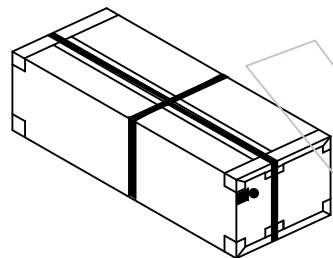

No: 8

打包装带

## 说明:

1. 产品如图所示型态放入真空管
2. 注意各标签样式、位置及方向的一致性;
3. 打外箱包装带时需注意, 打为十字型。

2.0筒牛, SMT, 加两层塑胶, L=19.0包装规范

规格	真空管 装数量	每内箱 装数量	每外箱 装数量	规格	真空管 装数量	每内箱 装数量	每外箱 装数量
6P	67	4020	8040	26P	20	1200	2400
8P	54	3240	6480	28P	18	1080	2160
10P	46	2760	5520	30P	17	1020	2040
12P	39	2340	4680	32P	16	960	1920
14P	34	2040	4080	34P	15	900	1800
16P	31	1860	3720	40P	13	780	1560
18P	28	1680	3360	44P	12	720	1440
20P	25	1500	3000	50P	11	660	1320
22P	23	1380	2760	60P	9	540	1080
24P	21	1260	2520	64P	8	480	960

变更记事

版次 REV	日期 DATE	变更说明 MODIFICATION DESCRIPTION	变更 CHANGE	核准 APPROVE	零件图		颜色 COLOR	材质 MATERIAL	设计 DESIGN	审核 CHECK	核准 APPROVE	SCALE	1:1	UNIT	mm	SIZE	A4	SHEET	1/1	PROJ.	
					X.	TOL															
A1	10/08/07	变更包材为SG-B18			X.X	±0.20			马云青												
A0	10/08/03	NEW			X.XX	±0.10															
					X.XXX	±0.05															
					Angle																
					X.	± 2'															

# WCON

WCON Electronics (GUANGDONG) Co., Ltd

料号 PART NO. 3123-XXMXXBD00TX

品名 TITLE: 2.0筒牛, SMT, 加两层塑胶, L=19.0包装规范